



PUHY-P550YSHM-A

Standard Y Series 22hp Outdoor Unit

R410A Heat Pump



The City Multi Standard Y Series makes use of a two pipe refrigerant circuit throughout, with the choice of either Branch Pipe or Header Pipe feeds to indoor units, with manual changeover from cooling to heating to ensure that a constant indoor climate is maintained.

- **High Sensible Cooling Function – By raising off coil temperature, a 10% increase in sensible cooling capacity over standard operation is achievable, the result being greater comfort for occupants**
- **Refrigerant Volume Checking Function can indicate if a leakage has occurred by measuring various temperature and pressures around the system, allowing customers to easily comply with the F-Gas regulation**
- **Replace Technology Function allows the re-use of refrigerant piping, controllers, power and control wiring for all previously installed R22 and R407c Heat Recovery and Cooling Only systems**
- **Energy-saving 100% inverter driven outdoor compressor units with very low start currents**



Pictures not to scale

Product Details

PUHY-P550YSHM-A	
Capacity (kW):	
Heating (Nominal)	69.0
Cooling (Nominal)	63.0
Heating (UK)	60.0
Cooling (UK)	58.0
Power Input (kW) Heating (Nominal)	18.06
Power Input (kW) Cooling (Nominal)	18.36
Power Input (kW) Heating (UK)	16.43
Power Input (kW) Cooling (UK)	12.85
Max No. of Connectable Indoor Units	47
Airflow(m ³ /min)	185 /185
Noise (dBA)	60.5
Width - mm	920 + 920
Depth - mm	760
Height - mm	1710
Weight - kg	200 + 215
Electrical Supply	380-415v, 50Hz
Phase	3
Mains Cable No. Cores	4 + earth
Starting Current (A)	8
Running Current (A) - Heating	27.9
Running Current (A) - Cooling	28.3

Piping Restrictions

Total Piping Length (m)	1000
Furthest Piping Length (m)	165
Furthest Piping Length after 1st Branch (m)	40
Between Indoor and Outdoor Units - Height (m)	50
Between Indoor and Indoor Units - Height (m)	15

Dimensions

PUHY-P550YSHM-A

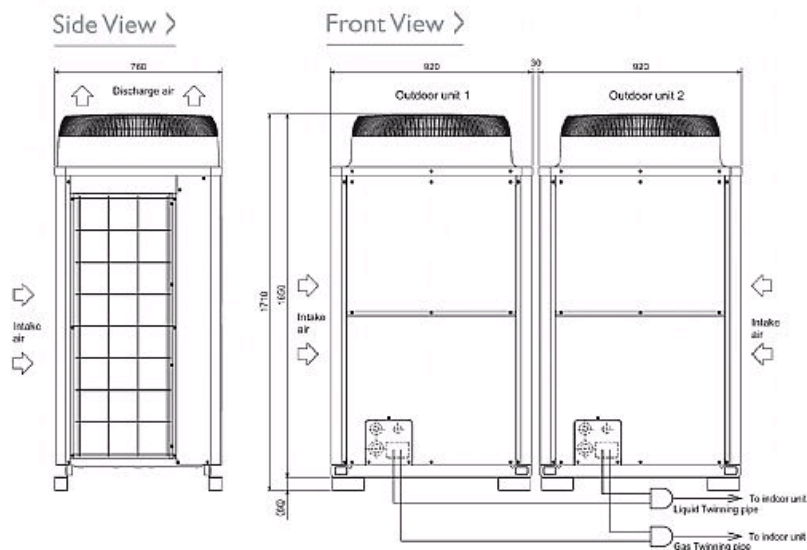

Telephone: 01707 282880

Email: air.conditioning@meuk.mee.com Website: <http://www.mitsubishielectric.co.uk/aircon>

Mitsubishi Electric reserves the right to make any variation in technical specification to the equipment described, or to withdraw or replace products without prior notification or public announcement.

Tel:
Fax:

